

Overload Relays — XTOB, XTOT

Contents

Description	Page
Overload Relays — XTOB, XTOT	
Catalog Number Selection	94
Product Selection	95
Accessories	96
Technical Data and Specifications	98
Dimensions	100
Reference Data	199



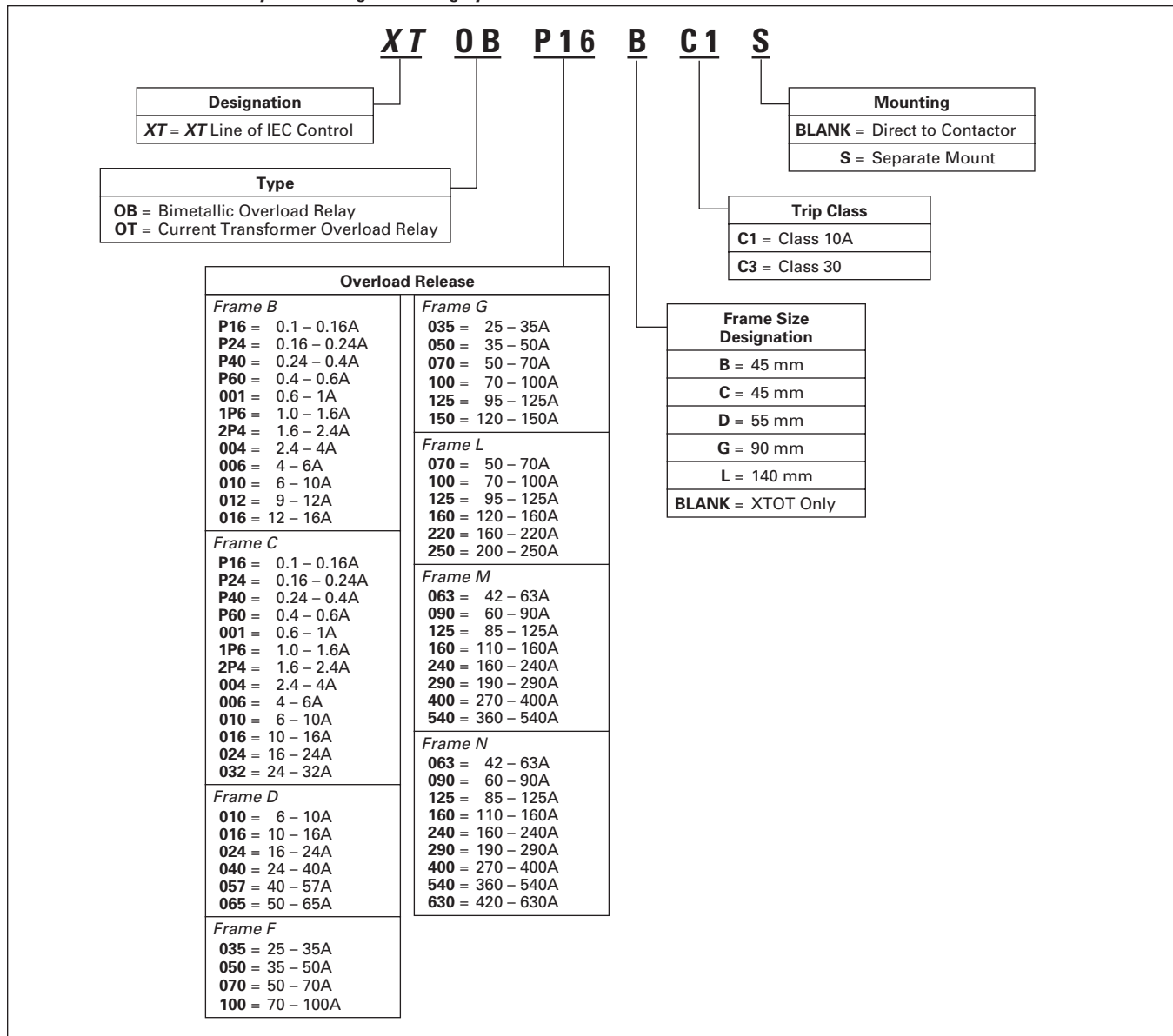
XTOB Overload Relay



XTOT Overload Relay

Catalog Number Selection


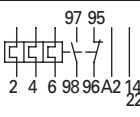
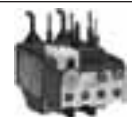
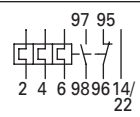

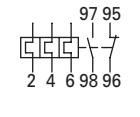

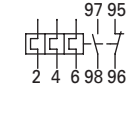

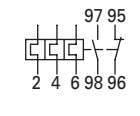
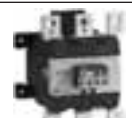
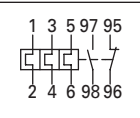
Table 124. XTIEC Overload Relays — Catalog Numbering System



Overload Relays — XTOB, XTOT

Product Selection

Table 125. Overload Relay

	Overload Releases, I _r	Contact Sequence	Contact Configuration	For Use with Contactor Amp Range	Short-Circuit Protection (A)				Catalog Number	Price U.S. \$	
					Fuse		Maximum Circuit Breaker	CEC/NEC Fuse			
					Type 1 Coordination, gG/gL	Type 2 Coordination, gG/gL					
Frame B — Direct Mount											
	0.1 – 0.16 0.16 – 0.24 0.24 – 0.4 0.4 – 0.6		1NO-1NC	7 – 15A	25	0.5	25	3	XTOBP16BC1	75.00	
			1NO-1NC	7 – 15A	25	1	25	3	XTOBP24BC1	75.00	
			1NO-1NC	7 – 15A	25	2	25	3	XTOBP40BC1	75.00	
			1NO-1NC	7 – 15A	25	4	25	3	XTOBP60BC1	75.00	
	0.6 – 1 1 – 1.6 1.6 – 2.4 2.4 – 4			1NO-1NC	7 – 15A	25	4	25	3	XTOB001BC1	75.00
				1NO-1NC	7 – 15A	25	6	25	6	XTOB1P6BC1	75.00
				1NO-1NC	7 – 15A	25	10	25	6	XTOB2P4BC1	75.00
				1NO-1NC	7 – 15A	25	16	25	15	XTOB004BC1	75.00
	4 – 6 6 – 10 9 – 12 12 – 16			1NO-1NC	7 – 15A	25	20	25	20	XTOB006BC1	75.00
				1NO-1NC	7 – 15A	50	25	25	35	XTOB010BC1	75.00
				1NO-1NC	9 – 15A	50	25	25	45	XTOB012BC1	75.00
				1NO-1NC	12 – 15A	50	25	30	45	XTOB016BC1	84.50
Frame C — Direct Mount											
	0.1 – 0.16 0.16 – 0.24 0.24 – 0.4 0.4 – 0.6		1NO-1NC	18 – 32A	25	0.5	25	3	XTOBP16CC1	80.00	
			1NO-1NC	18 – 32A	25	1	25	3	XTOBP24CC1	80.00	
			1NO-1NC	18 – 32A	25	2	25	3	XTOBP40CC1	80.00	
			1NO-1NC	18 – 32A	25	4	25	3	XTOBP60CC1	80.00	
	0.6 – 1 1 – 1.6 1.6 – 2.4 2.4 – 4			1NO-1NC	18 – 32A	25	4	25	3	XTOB001CC1	80.00
				1NO-1NC	18 – 32A	25	6	25	6	XTOB1P6CC1	80.00
				1NO-1NC	18 – 32A	25	10	25	6	XTOB2P4CC1	80.00
				1NO-1NC	18 – 32A	25	16	25	15	XTOB004CC1	80.00
	4 – 6 6 – 10 10 – 16 16 – 24 24 – 32			1NO-1NC	18 – 32A	25	20	25	20	XTOB006CC1	80.00
				1NO-1NC	18 – 32A	50	25	25	25	XTOB010CC1	80.00
				1NO-1NC	18 – 32A	63	35	30	25	XTOB016CC1	80.00
				1NO-1NC	18 – 32A	100	35	30	25	XTOB024CC1	80.00
1NO-1NC	25 – 32A	125	63	30	25	XTOB032CC1	94.00				
Frame D — Direct Mount											
	6 – 10 10 – 16 16 – 24		1NO-1NC	40 – 65A	50	25	25	25	XTOB010DC1	102.00	
			1NO-1NC	40 – 65A	63	35	25	25	XTOB016DC1	102.00	
			1NO-1NC	40 – 65A	63	50	30	25	XTOB024DC1	120.00	
	24 – 40 40 – 57 50 – 65			1NO-1NC	40 – 65A	125	63	125	125	XTOB040DC1	120.00
				1NO-1NC	50 – 65A	160	80	150	150	XTOB057DC1	135.00
				1NO-1NC	65A	160	100	150	200	XTOB065DC1	135.00
Frame F – G — Direct Mount											
	25 – 35 35 – 50 50 – 70		1NO-1NC	80 – 150A	125	100	125	125	XTOB035GC1	194.00	
			1NO-1NC	80 – 150A	160	125	150	200	XTOB050GC1	194.00	
			1NO-1NC	80 – 150A	250	160	150	200	XTOB070GC1	194.00	
	70 – 100 95 – 125 120 – 150			1NO-1NC	80 – 150A	315	200	400	400	XTOB100GC1	194.00
				1NO-1NC	80 – 150A	315	250	500	400	XTOB125GC1	288.00
				1NO-1NC	80 – 150A	315	250	600	600	XTOB150GC1	288.00
Frame F – G — Separate Mount											
	25 – 35 35 – 50 50 – 70		1NO-1NC	80 – 150A	125	100	125	125	XTOB035GC1S	202.00	
			1NO-1NC	80 – 150A	160	125	150	200	XTOB050GC1S	202.00	
			1NO-1NC	80 – 150A	250	160	150	200	XTOB070GC1S	202.00	
	70 – 100 95 – 125 120 – 150			1NO-1NC	80 – 150A	315	200	400	400	XTOB100GC1S	202.00
				1NO-1NC	80 – 150A	315	250	500	400	XTOB125GC1S	304.00
				1NO-1NC	80 – 150A	315	250	600	600	XTOB150GC1S	304.00
Frame L											
	50 – 70 70 – 100 95 – 125		1NO-1NC	185 – 250A	250	160	150	200	XTOB070LC1	426.00	
			1NO-1NC	185 – 250A	315	200	400	400	XTOB100LC1	400.00	
			1NO-1NC	185 – 250A	315	250	500	400	XTOB125LC1	400.00	
	120 – 160 160 – 220 200 – 250			1NO-1NC	185 – 250A	400	250	600	600	XTOB160LC1	416.00
				1NO-1NC	185 – 250A	400 ①	315 ①	800	800	XTOB220LC1	416.00
				1NO-1NC	225 – 250A	400 ①	315 ①	600	700	XTOB250LC1	416.00

① For separate mounting, short circuit Type 1 rating is 500A and short circuit Type 2 rating is 400A.

Notes:

Short circuit protection: Observe the maximum permissible fuse of the contactor with direct device mounting. See MN03402001E for more information on overload relays for Frame B – G.

Trip Class: 10A

Suitable for protection of EEx e-motors. EC prototype test certificate available upon request.

Observe manuals MN03402001E and MN03407001E, see **Table 129**.

Technical Data **Page 98**
Dimensions **Page 100**
Discount Symbol **1CD7**

Overload Relays — XTOB, XTOT

Table 126. Current Transformer Operated Overload Relays ①

	Overload Releases, I _r	Contact Sequence	Contact Configuration	For Use with Contactor Amp Range	Short-Circuit Protection (A)				Catalog Number	Price U.S. \$
					Type 1 Coordination, gG/gL	Type 2 Coordination, gG/gL	Circuit Breaker	CEC/NEC Fuse		
Frame M – N — Separate Mount										
	42 – 63		1NO-1NC	300 – 500A	—	—	150	200	XTOT063C3S	530.00
	60 – 90		1NO-1NC	300 – 500A	—	—	250	250	XTOT090C3S	530.00
	85 – 125		1NO-1NC	300 – 500A	—	—	500	400	XTOT125C3S	605.00
	110 – 160		1NO-1NC	300 – 500A	—	—	600	600	XTOT160C3S	605.00
	160 – 240		1NO-1NC	300 – 500A	—	—	600	700	XTOT240C3S	710.00
	190 – 290	1NO-1NC	300 – 500A	—	—	600	700	XTOT290C3S	710.00	
	270 – 400	1NO1-NC	300 – 500A	—	—	1000	1000	XTOT400C3S	710.00	
	360 – 540	1NO-1NC	500A	—	—	600	1000	XTOT540C3S	810.00	
	420 – 630	1NO-1NC	630A	—	—	600	1000	XTOT630C3S	810.00	

① The main current parameters are defined by the main current wiring which is used.

Accessories

Table 127. DIN Rail or Panel Mount Adapter, Frame C – D ②

	For Use with...	Pkg. Qty.	Catalog Number	Price U.S. \$
	XTOB...CC1	5	XTOBXDINC	18.20
	XTOB...DC1	1	XTOBXDIND	38.50

② Can be snap fitted on a top hat rail (DIN rail) to IEC/EN 60715 or can be screw fitted.

Table 128. Terminal Shroud

	For Use with...	Catalog Number	Price U.S. \$
	XTOB...LC1	XTOBXTSL	69.50
	For direct mounting of ...	Catalog Number	Price U.S. \$
	XTOB...LC1 to XTCE185L, XTCE225L or XTCE250L	XTOBXTSCL	47.00

Table 129. Documentation — Manuals for Overload Monitoring of EEX e-motors

Publication Number	For Use with...
MN03402001E	XTOB...BC1 XTOB...CC1
MN03407001E	XTOB...DC1 XTOB...GC1

Overload Relays — XTOB, XTOT

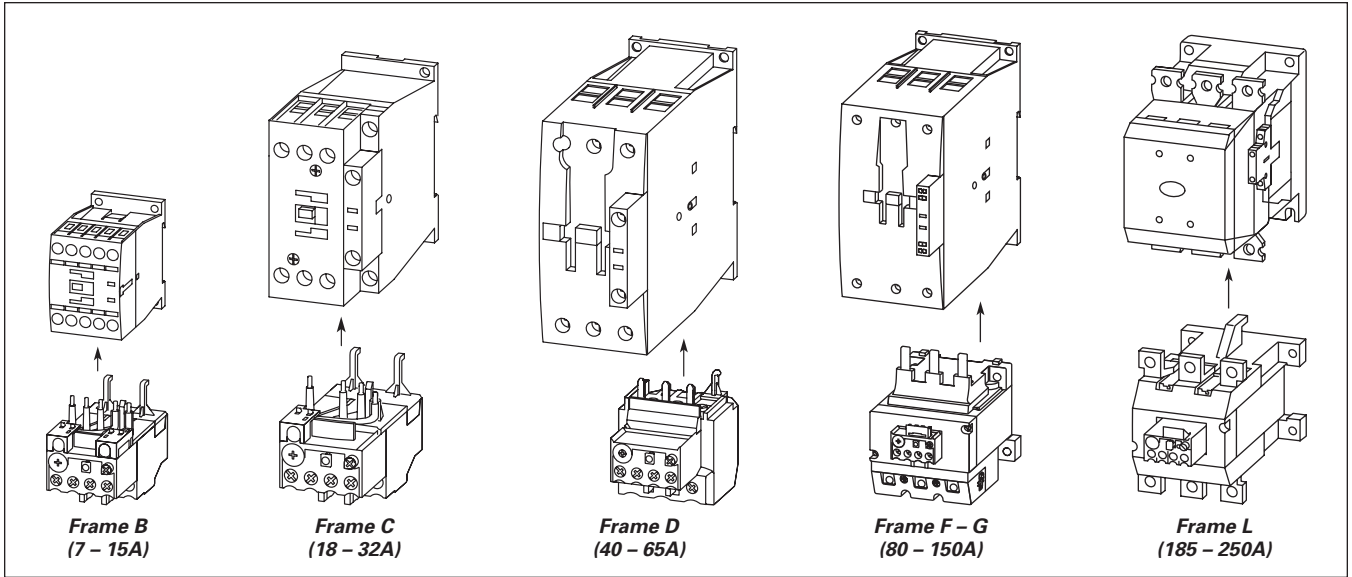


Figure 74. Overload Fitted Directly to the Contactor

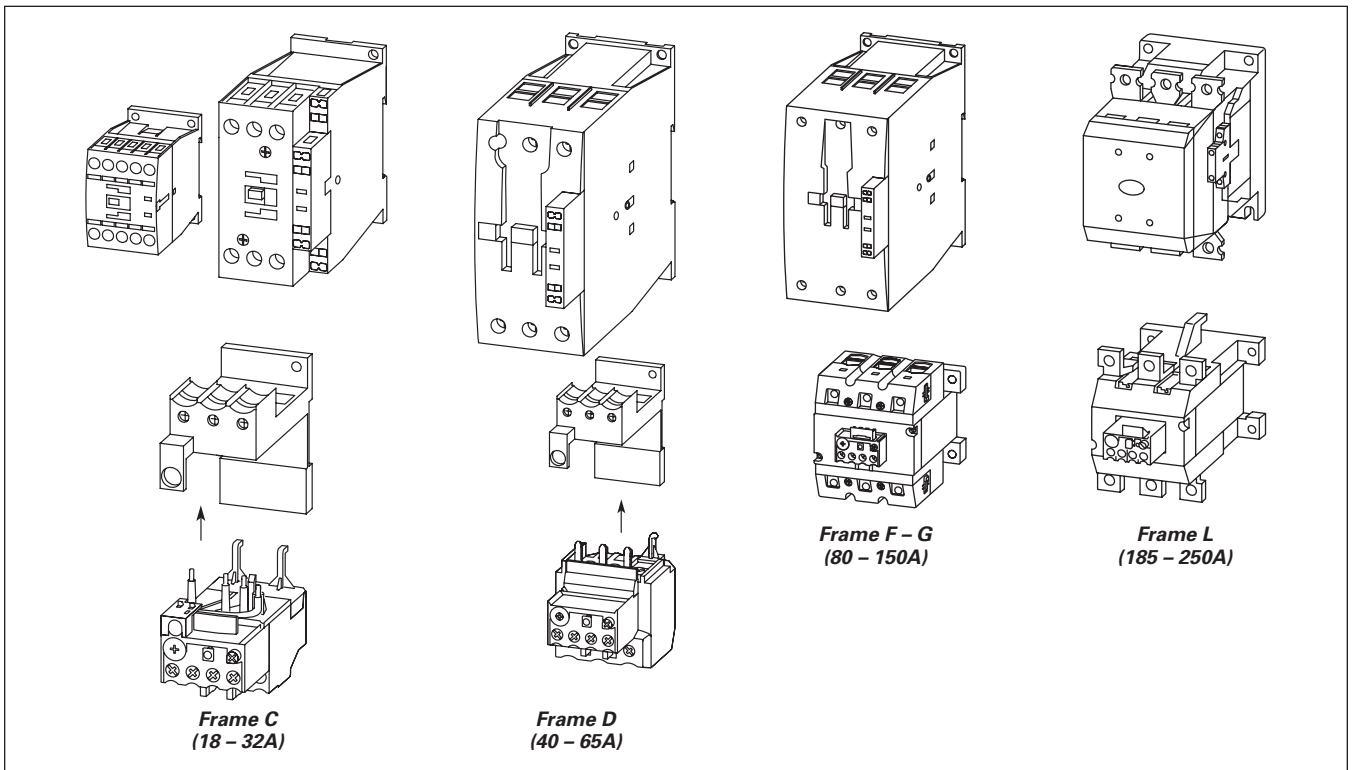


Figure 75. Overload Mounted Separately from the Contactor

Overload Relays — XTOB, XTOT

Technical Data and Specifications

Table 130. XTOB Overload Relay — Technical Data and Specifications

Description	XTOB...BC1, XTOB...CC1	XTOB...DC1	XTOB...GC1, XTOB...GC1S	XTOB...LC1
General				
Standards	IEC/EN 60947, VDE 0660, UL, CSA			
Climate Proofing	Damp heat, constant, to IEC 60068-2-78; Damp heat, cyclic, to IEC 60068-2-30			
Ambient Temperature ①	-25°C to +55°C [-13°F to 131°F]	-25°C to +55°C [-13°F to 131°F]	-25°C to +55°C [-13°F to 131°F]	-25°C to +50°C [-13°F to 122°F]
Temperature Compensation	Continuous	Continuous	Continuous	Continuous
Mechanical Shock Resistance (IEC/EN 60068-2-27) Half-Sinusoidal Shock 10 mS	10g	10g	10g	10g
Degree of Protection	IP20	IP20	IP20	P00
Protection Against Direct Contact when Actuated from Front (IEC 536)	Finger and back of hand proof	Finger and back of hand proof	Finger and back of hand proof	With terminal cover XTOBXTS...L
Insulation Voltage (Ui) V AC	690	690	690	1000
Overvoltage Category / Pollution Degree	III/3	III/3	III/3	III/3
Impulse Withstand Voltage (Uimp) V AC	6000	6000	6000	8000
Operational Voltage (Ue) V AC	690	690	690	1000
Safe Isolation to VDE 0106 Part 101 and part 101/A1 Between auxiliary contacts and main contacts (V AC) Between main contacts (V AC)	440 440	440 440	440 440	440 440
Overload Release Setting Range	0.1 – 32A	6 – 75A	25 – 150A	50 – 250A
Short Circuit Protection Maximum Fuse	See Table 125 on Page 95.			
Temperature Compensation Residual Error > 40°C	<-0.25	<-0.25	<-0.25	<-0.25
Current Heat Loss (3 Conductors) Lower value of setting range, W Upper value of setting range	2.5 6	3 7.5	16 28	16 28
Terminal Capacity Solid, mm ² Flexible with ferrule, mm ² Flexible with cable lug, mm ² Stranded with cable lug, mm ²	2 x (1 – 6) 2 x (1 – 4) 2 x (1 – 6) ② — —	2 x (1 – 16) 1 x 25 2 x (1 – 10) ③ — —	2 x (4 – 16) 1 x (4 – 70) 2 x (4 – 50) — —	— — — 95 120
Solid or Stranded, AWG	14 – 8	14 – 2	2 / 0	250MCM
Flat Conductor (number of segments x width x thickness, mm ²)	—	—	—	6 x 16 x 18
Busbar — Width (mm)	—	—	—	20 x 3
Terminal Screw Tightening Torque Nm Lb-in	M4 1.8 16	M6 3.5 31	M10 10 88.5	M8 x 25 24 221.3
Tools Pozi driv screwdriver Standard screwdriver Hexagon socket head spanner (SW)	Size 2 1 x 6 —	Size 2 1 x 6 —	— — 5 mm	— — 13 mm
Auxiliary and Control Circuit Connections				
Impulse Withstand Voltage (Uimp) V AC	6000	6000	6000	6000
Overvoltage Category/Pollution Degree	III/3	III/3	III/3	III/3
Terminal Capacity Solid, mm ² Flexible with ferrule, mm ² Solid or Stranded (AWG)	2 x (0.75 – 4) 2 x (0.75 – 2.5) 2 x (18 – 12)	2 x (0.75 – 4) 2 x (0.75 – 2.5) 2 x (18 – 12)	2 x (0.75 – 4) 2 x (0.75 – 2.5) 2 x (18 – 12)	2 x (0.75 – 4) 2 x (0.75 – 2.5) 2 x (18 – 12)
Terminal Screw Tightening Torque Nm Lb-in	M3.5 0.8 – 1.2 7 – 10.6	M3.5 0.8 – 1.2 7 – 10.6	M3.5 0.8 – 1.2 7 – 10.6	M3.5 0.8 – 1.2 7 – 10.6
Tools Pozi driv screwdriver Standard screwdriver	Size 2 1 x 6	Size 2 1 x 6	Size 2 1 x 6	Size 2 1 x 6
Rated Insulated Voltage (Ui) V AC	500	500	500	500
Rated Operational Voltage	500	500	500	500
Safe Isolation to VDE 0106 Part 101 and part 101/A1 Between auxiliary contacts	240	240	240	240
Conventional Thermal Current, I _{th}	6	6	6	—

① Ambient Temperature Operating Range to IEC/EN 60947, PTB: -5°C to +50°C.

 ② 6 mm² flexible with ferrules to DIN 46228.

③ Main contact terminal capacity, solid and stranded conductors with ferrules: When using 2 conductors use identical cross-section.

Overload Relays — XTOB, XTOT

Table 130. XTOB Overload Relay — Technical Data and Specifications (Continued)

Description	XTOB...BC1, XTOB...CC1	XTOB...DC1	XTOB...GC1, XTOB...GC1S	XTOB...LC1
Auxiliary and Control Circuit Connections (Continued)				
Rated Operational Current — AC-15 Make Contact 120V 240V 415V 500V	1.5 1.5 0.5 0.5	1.5 1.5 0.5 0.5	1.5 1.5 0.5 0.5	1.5 1.5 0.5 0.5
Break Contact 120V 240V 415V 500V	1.5 1.5 0.9 0.8	1.5 1.5 0.9 0.8	1.5 1.5 0.9 0.8	1.5 1.5 0.9 0.8
Rated Operational Current — DC-13 L/R ≤ 15 mS ① 24V 60V 110V 220V	0.9 0.75 0.4 0.2	0.9 0.75 0.4 0.2	0.9 0.75 0.4 0.2	0.9 0.75 0.4 0.2
Short Circuit Rating without Welding Maximum Fuse, A gG/gI	6	6	6	6

① Rated operational current: Making and breaking conditions to DC-13, L/R constant as stated.

Tripping Characteristics

These tripping characteristics are the mean values of the spread at 20°C ambient temperature in a cold state.

Tripping time depends on response current. With devices at operating temperature, the tripping time of the overload relay reduces to approximately 25% of the read off value. Specific characteristics for each individual setting range can be found in MN03402001E.

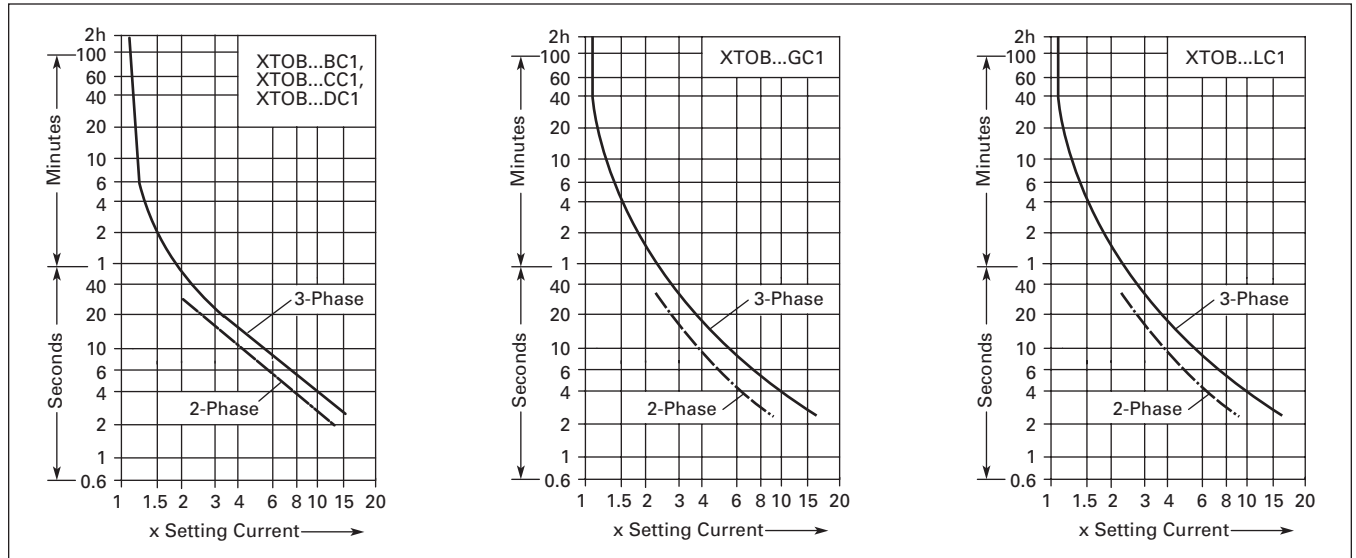


Figure 76. Tripping Characteristics

Instructional Leaflets

Table 131. Instructional Leaflets

Publication Number	Description
Pub51221	XTOB, D Frame Overload Relays (Inside of Packaging)
Pub51222	XTOB, B – C Frame Overload Relays (Inside of Packaging)

Overload Relays — XTOB, XTOT

Dimensions

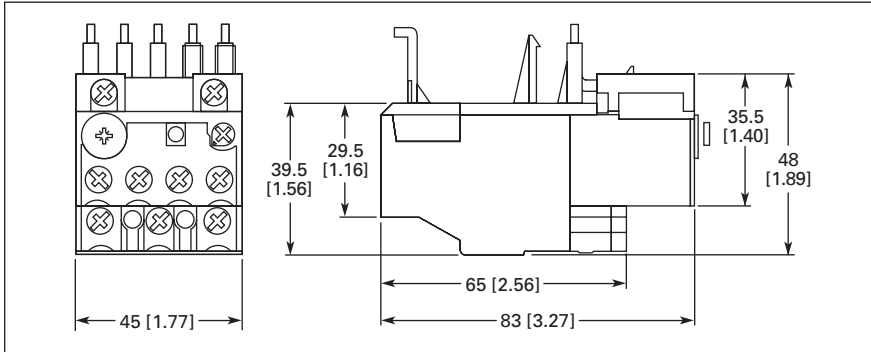


Figure 77. Frame B – C, XTOB...BC1 and XTOB...CC1 Overload Relays — Approximate Dimensions in mm [in]

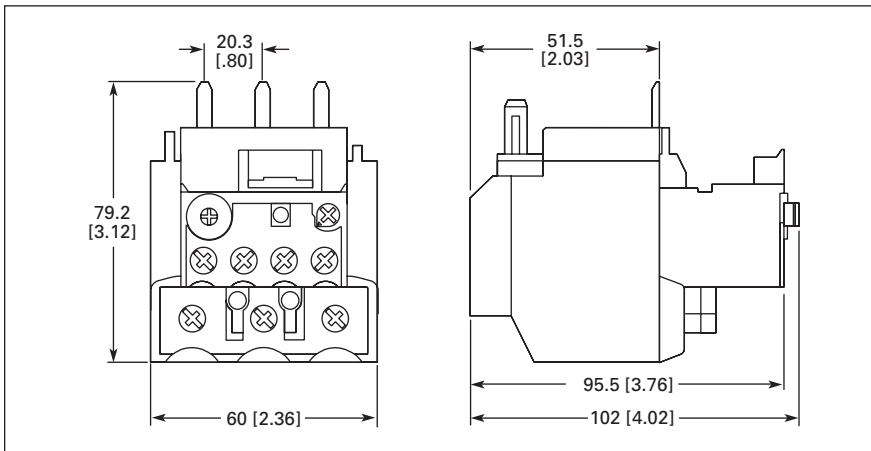


Figure 78. Frame D, XTOB...DC1 Overload Relay — Approximate Dimensions in mm [in]

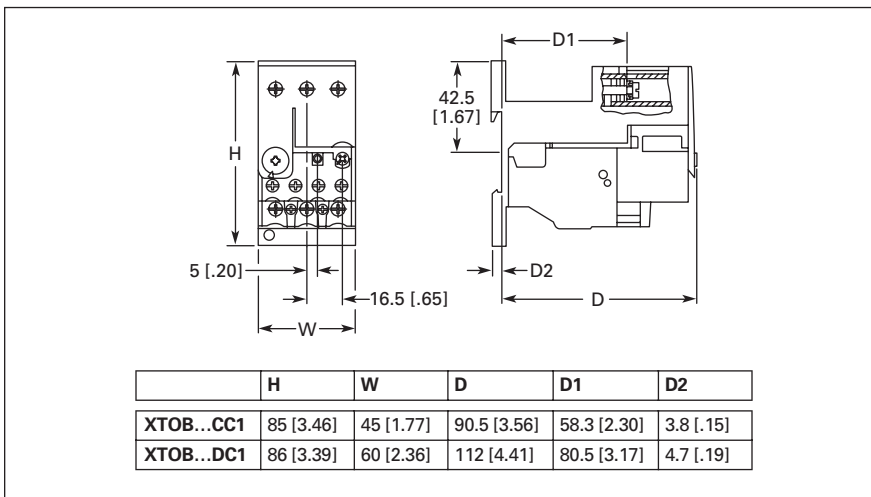


Figure 79. Frame B – C, XTOBXDINC DIN Rail or Panel Mount Adapter and Frame D, XTOBXDIND DIN Rail or Panel Mount Adapter — Approximate Dimensions in mm [in]

Overload Relays — XTOB, XTOT

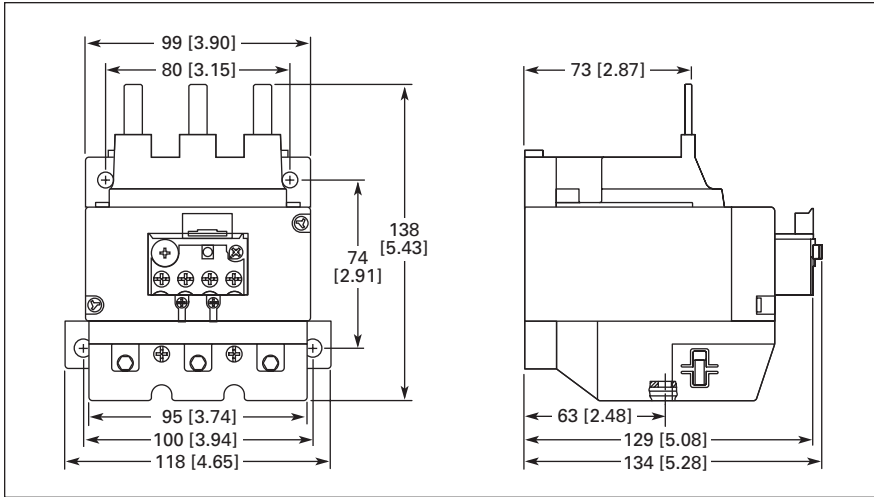


Figure 80. Frame F – G, XTOB...GC1 Overload Relay — Approximate Dimensions in mm [in]

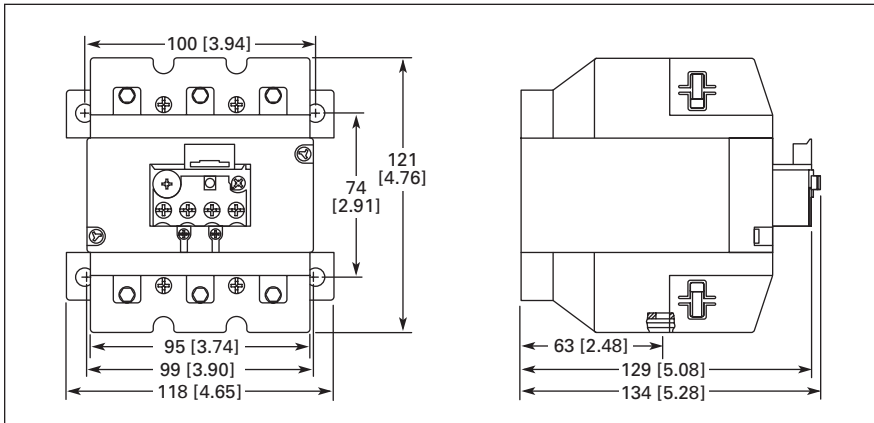


Figure 81. Frame F – G, XTOB...G1CS Overload Relay — Approximate Dimensions in mm [in]

Overload Relays — XTOB, XTOT

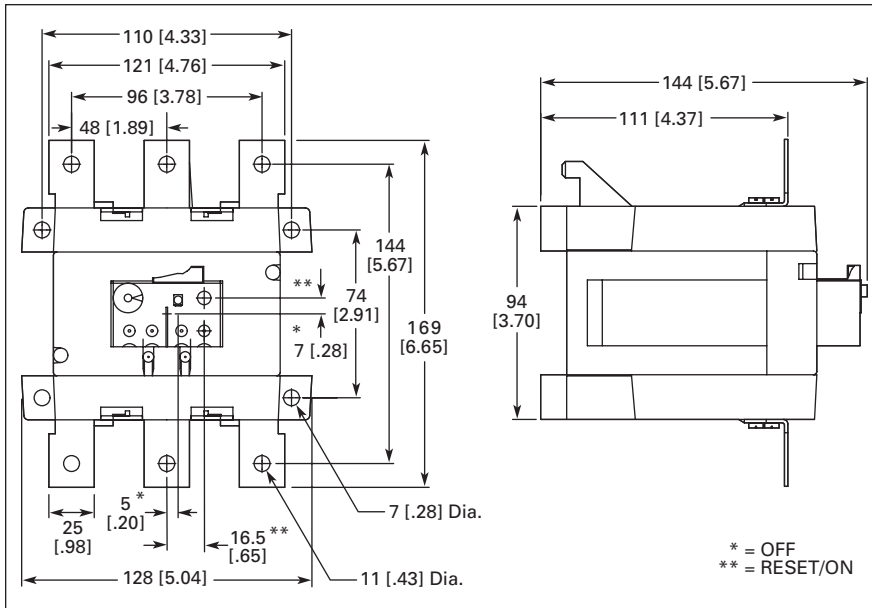


Figure 82. Frame L, XTOB...LC1 Overload Relay — Approximate Dimensions in mm [in]

Current Transformer Operated Overload Relay

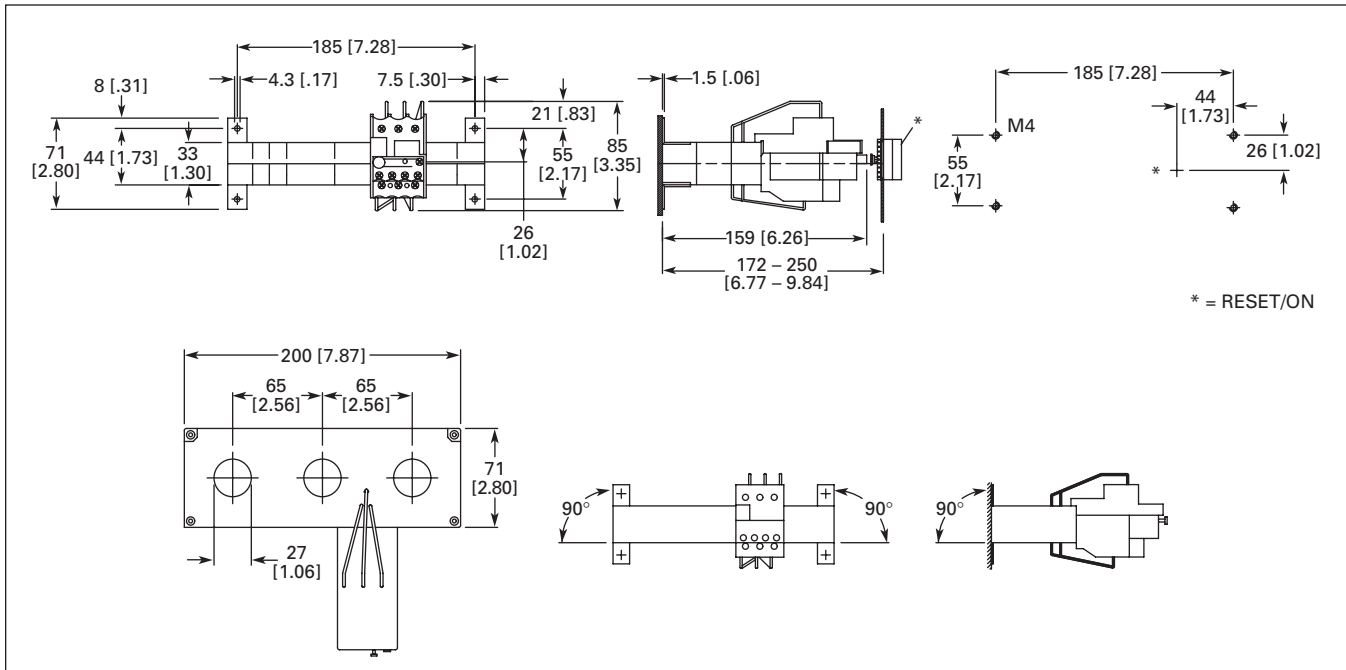


Figure 83. XTOT...C3S — Approximate Dimensions in mm [in]